

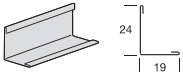

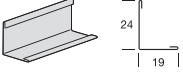





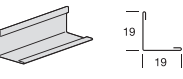

PERIMETER SOLUTIONS

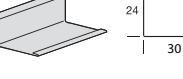
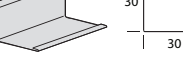
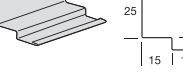
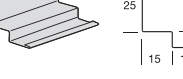
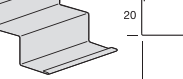
A comprehensive range of the most commonly used perimeter profiles, including shadowline, F upstands and cover plates, finished to match all Prelude 24 mm and 15 mm, Bandraster and Prelude 35 grid systems.

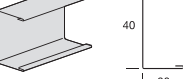
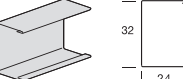
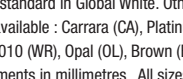

Item Nr.	Description	Dimensions		Content / Carton		Weight / Carton kg
		length (mm)	thickness (mm)	pcs	lm	
 T 1924 HD	Perimeter angle, painted	3000	0,54	36	108,00	22,70
 T 1924 CA ⁽¹⁾	Perimeter angle, capped	3050	0,60	36	109,80	27,60
 T 1924 LB	Perimeter angle, corrosive resistant	3050	0,55	36	109,80	27,60
 T 1932 HA	Perimeter angle, painted	3000	0,45	36	108,00	21,80
 T 1919 HC	Perimeter angle, painted	3000	0,45	36	108,00	19,30
 T 2401 H	Perimeter angle, painted heavy duty	3050	0,70	30	91,50	22,00
 T 2400 H	Perimeter angle, painted intermediate duty	3050	0,60	30	91,50	20,00
 T 2424 HC	Perimeter angle, painted	3050	0,45	36	109,80	21,60
 T 3024 H	Perimeter angle, painted	3000	0,45	40	120,00	28,50
 T 3030 H	Perimeter angle, painted	3000	0,54	30	90,00	25,00
 T 1506 H	Shadowline, painted	3050	0,45	36	109,80	26,30
 T 1508 HB	Shadowline, painted	3050	0,45	36	109,80	27,10
 T 2020 HH	Shadowline, painted	3000	0,65	20	60,00	27,00
 7875 G	Shadowline, painted, for Optima Vector, Ultima Vector, Sahara Vector	3050	0,45	30	91,50	26,80
 T 2121 HG	Shadowline, air circulation length of slot: 50 mm Distance between slots 20 mm (ca. 16% open area)	3000	0,60	25	75,00	41,20
 T 2040 HB	C channel, painted	3050	0,45	20	61,00	18,10
 7837	C channel, painted	3050	0,45	24	73,10	21,80

All products standard in Global White. Other standard colours available for item numbers with index (1). See details below.

(1) Colours available : Carrara (CA), Platinum (PN), Black (BK), RAL 9006 (SG), Brass (BS), Chrome (CE), White RAL 9010 (WR), Opal (OL), Brown (BN), Ivory (IY), Blue (BE), Red (RD), Green (GN).

All measurements in millimetres. All sizes are nominal.

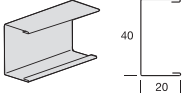
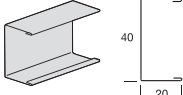
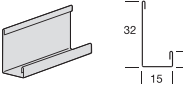
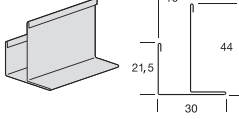
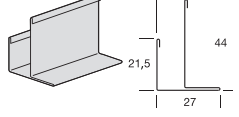
Perimeter Trims

Item Nr.	Description	Dimensions		Content / Carton		Weight / Carton kg
		length (mm)	thickness (mm)	pcs	lm	
	T 2040 H WR A C channel, colour RAL 9010	3050	0,50	20	61,00	18,10
	T 2040 H SG A C channel colour RAL 9006	3050	0,45	20	61,00	18,10
	T 1575 HA Unequal U-Profile, painted	3050	0,45	36	109,80	24,20
	7856 H F Upstand trim, painted, for 16 mm thick panels	3050	0,45	20	61,00	23,70
	7852 H F Upstand trim, painted, for 13 mm thick panels	3050	0,45	20	61,00	23,00
	T 2222 Perimeter angle*	3000	0,45	36	108,00	19,00

Perimeter Detailing

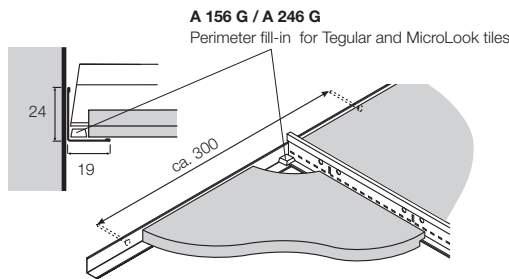

Standard perimeter finish with perimeter angle
T 1924 HD or **T 1924 CA**

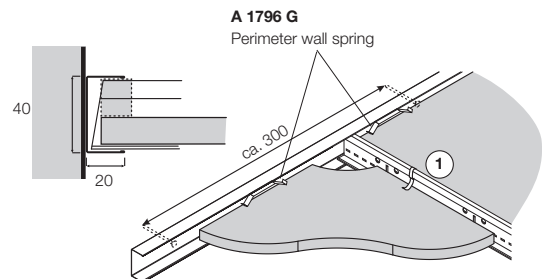

Perimeter finish with C channel **T 2040 HA**
① **A 7890 G** Universal retaining clip

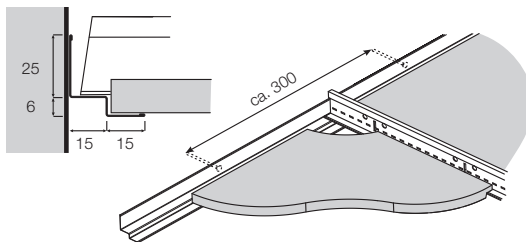

Perimeter finish with shadowline **T 1506 H**

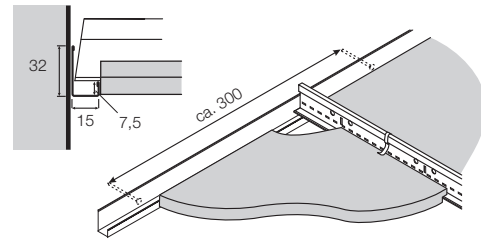

Perimeter finish with unequal U-Profile **T 1575 HA**

*Only available for the Scandinavian market.



Availability of products may vary according to location. Please contact our **Armstrong Technical Sales** for further details.



PERIMETER SOLUTIONS

Metal suspension system.

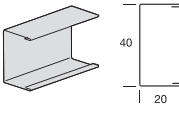
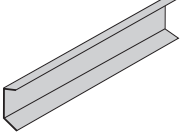
Perimeter Trims for Metal Ceilings

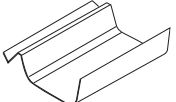
Item Nr.	Description	Dimensions length (mm)	Content / Carton pcs	Carton lm	Weight / Carton kg
	T 2040 H WR A	Perimeter channel RAL 9010 20x40 mm	3050	20 61,00	18,10
	C 1803 H	Perimeter wedge	200	100 -	5,00
	M 215013	Perimeter trim RAL 9010 25x25 mm	4000	10 40,00	8,00
	M 215014	Shadowline RAL9010 20x20x20x25 mm	4000	10 40,00	13,50
	M 215015	Shadowline RAL9010 20x15x10x25 mm	4000	10 40,00	11,00
	M 311081	Cut tile spring wedge	40	100 -	0,30

Perimeter trims also available in Global White.

Perimeter Detailing for Metal Ceilings

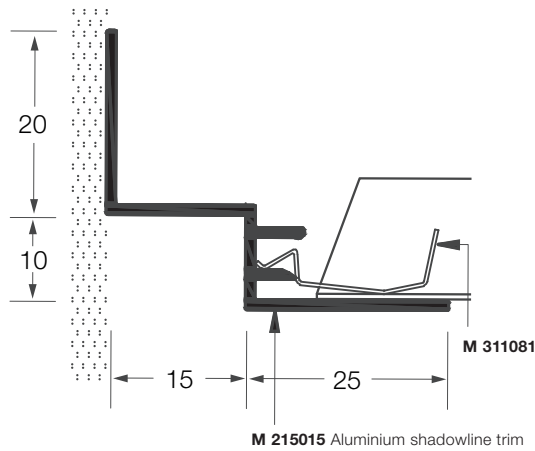
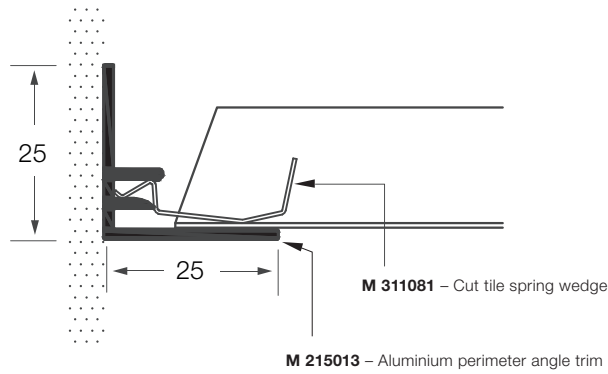

Cut Tile Spring Wedge **M 311081** -
1-2 pieces per 300mm of perimeter trim.

Perimeter wedge **C 1803 H** -
1 piece per 300mm of perimeter trim.

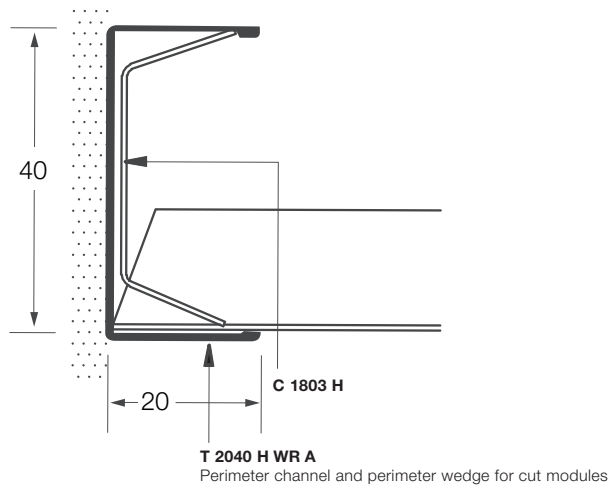

All measurements in millimetres. All sizes are nominal.

CENTRAL EUROPE SOUTH
(AL/BA/BG/CZ/HR/HU/KO/MD/ME/MK/RO/RS/SK/SI)
Armstrong Building Products
Lighthouse Building
Jankovcova 1569/2c
170 00 Praha 7
Czech Republic
Tel. : +420 234 700 543
e-mail : service-ce@armstrong.com

Czech Republic : www.armstrong.cz
Hungary : www.armstrong.co.hu
Romania : www.armstrong.ro
Serbia : www.armstrong.rs
Slovakia : www.armstrong.sk
Slovenia : www.armstrong.si

www.armstrong.eu